

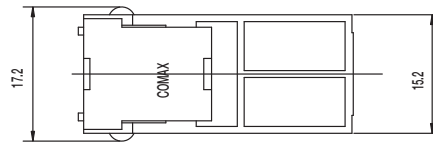

# Hook Switch

PART NUMBER	LIFE CYCLE	PACKAGING
<b>HS-2206-D NS</b>	100,000 cycles	5,000 pieces



TRAVEL POSITION (X)			
①	③	ON	OFF
②	③	OFF	ON
④	⑥	ON	OFF
⑤	⑥	OFF	ON
		0	1.5Min. 5.2Max. (m/m)

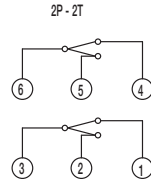
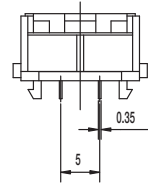
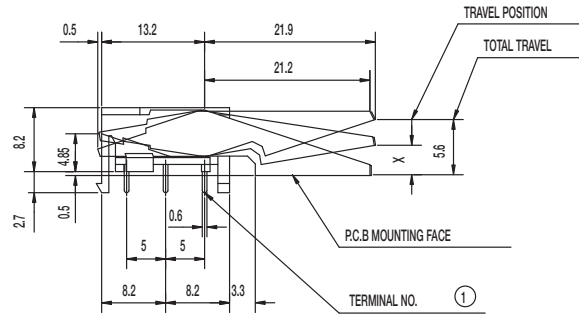

SCHEMATIC

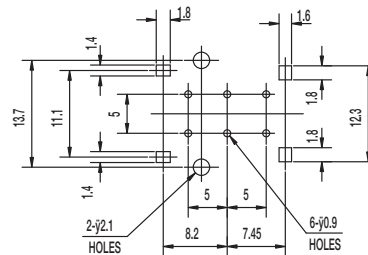

PIERCING PLAN

PART NUMBER	LIFE CYCLE	PACKAGING
<b>HS-2206-E NS</b>	100,000 cycles	5,000 pieces

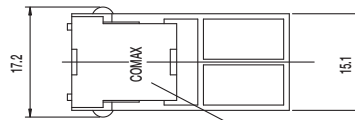

TRAVEL POSITION (X)			
①	③	ON	OFF
②	③	OFF	ON
④	⑥	ON	OFF
⑤	⑥	OFF	ON
		0	1.5Min. 5.9Max. (m/m)

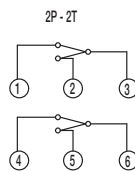
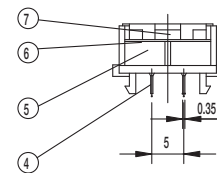
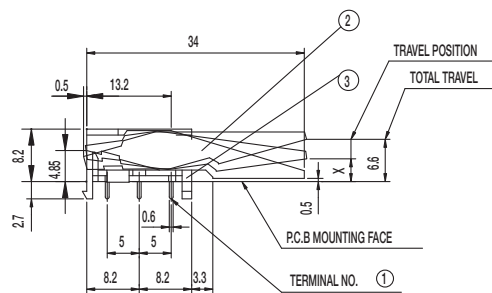

SCHEMATIC

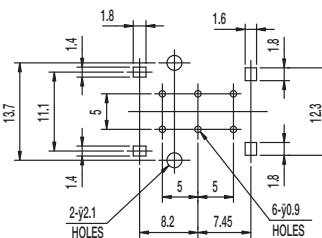

PIERCING PLAN



Dimensions are shown: mm  
Specifications and dimensions subject to change