

QT-Brightek PLCC Series

3020 White LED

Part No.: QBLP676-IW-XX

XX = WW/NW/CW

Product: QBLP676-IW-XX	Date: April 14, 2017	Page 1 of 10
	Version# 3.0	

Table of Contents:

Introduction	3
Electrical / Optical Characteristic (Ta=25 °C)	4
Absolute Maximum Rating	4
Correlated Color Temperature	5
Characteristic Curves.....	6
Solder Profile & Footprint.....	7
Packing	8
Labeling	9
Ordering Information	9
Revision History	10
Disclaimer	10

Introduction

Feature:

- Package in tape and reel
- Ultra bright reflector type 3020 PLCC 2 LED
- InGaN technology for IW
- 120 degree viewing angle
- CRI 80 typ.

Description:

This ultra-bright 3020 LED has a height profile of 1.30mm. Combination of high brightness output and robust package, this LED is ideal for back lighting, architecture lighting, and industrial equipment lighting applications.

Application:

- Status indication
- Industrial equipment backlighting
- Architecture lighting

Certification & Compliance:

- TS16949
- ISO9001
- RoHS Compliant



Dimension:

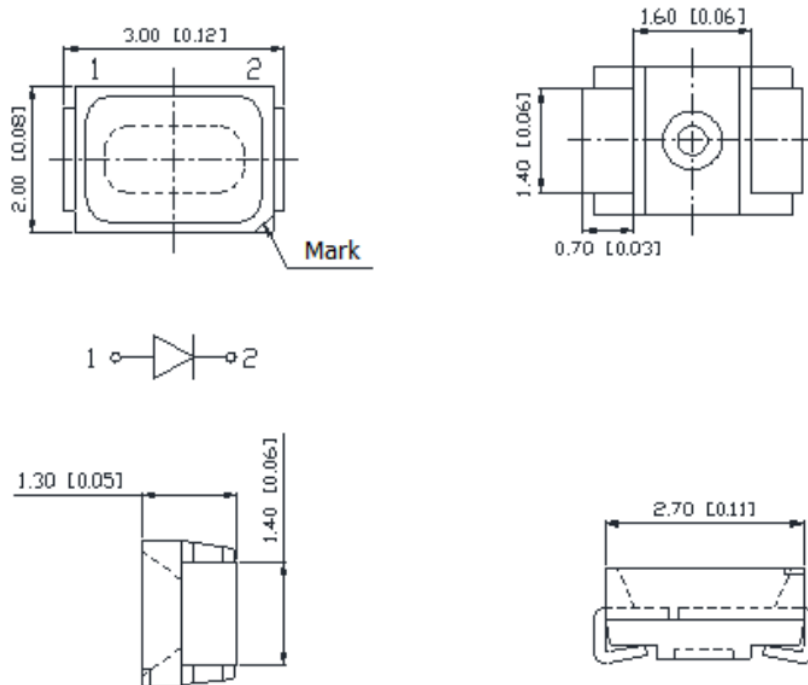

Units: mm / tolerance = +/-0.2mm

Electrical / Optical Characteristic (Ta=25 °C)

Product	Color	I _F (mA)	V _F (V)		CCT (K)			I _V (mcd)	
			Typ.	Max.	Min.	Typ.	Max.	Min.	Typ.
QBLP676-IW-WW	Warm White	20	3.0	3.4	2760	3000	3260	1600	1950
QBLP676-IW-NW	Natural White	20	3.0	3.4	3640	4000	4240	1600	2000
QBLP676-IW-CW	Cool White	20	3.0	3.4	5300	6020	7050	1600	2000

Absolute Maximum Rating

Material	P _d (mW)	I _F (mA)	I _{FP} (mA)*	V _R (V)	T _{OP} (°C)	T _{ST} (°C)	T _{SO L} (°C)**
InGaN	75	30	100	5	-40 ~ +85	-40 ~ +100	260

*Duty 1/10 @ 1KHz

**IR Reflow for no more than 10 sec @ 260 °C

Forward Voltage V_F @ I_F=20mA

Bin	Min.	Max.	Unit
G	2.6	2.8	V
H	2.8	3.0	
J	3.0	3.2	
K	3.2	3.4	

Luminous Intensity I_V @ I_F=20mA

Bin	Min.	Max.	Unit
L1	1600	1950	mcd
L2	1950	2400	
L3	2400	2880	
L4	2880	3450	
L5	3450	4150	

Note:

Tolerance of measurement of forward voltage: ±0.1V

Tolerance of measurement of luminous intensity: ±15%

Correlated Color Temperature (CCT) @ I_F=20mA

P/N	Bin	Min.	Max.	Unit
QBLP676-IW-WW	RN	2760	3260	K
QBLP676-IW-NW	RL	3640	4240	
QBLP676-IW-CW	RM	5300	6020	
	RR	6020	7050	

Correlated Color Temperature

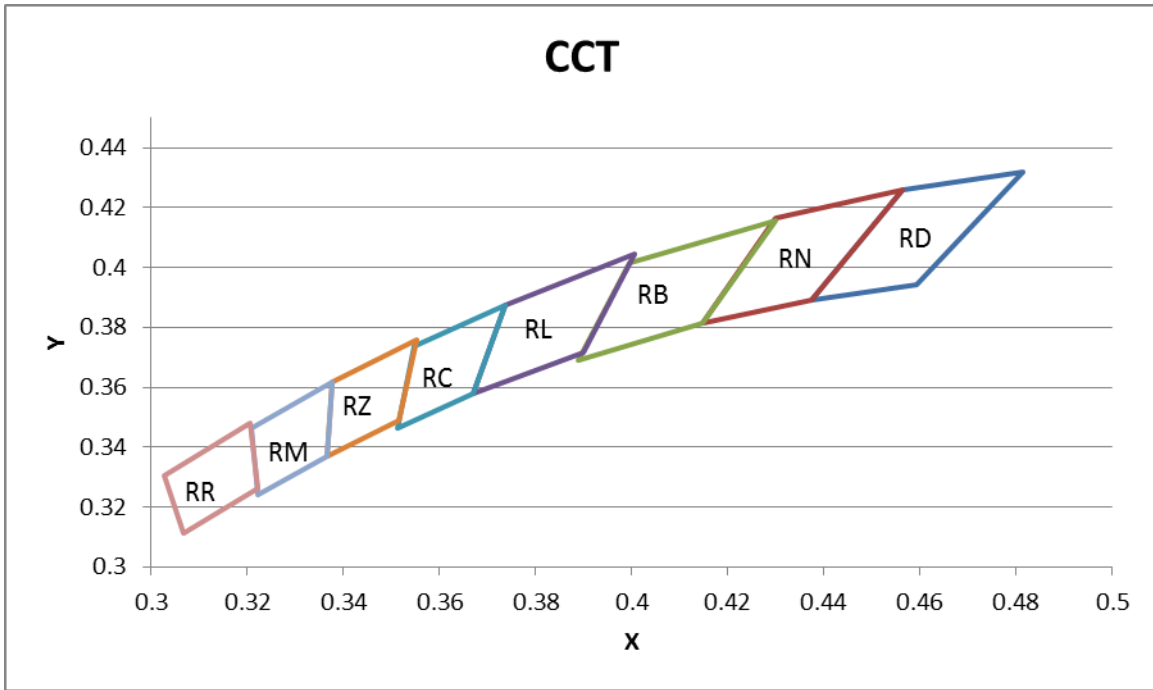

Color Ranks @ I _F =20mA							
QBLP676-IW-WW				QBLP676-IW-NW			
RD		RN		RB		RL	
0.4813	0.4319	0.4562	0.426	0.4299	0.4156	0.4006	0.4044
0.4562	0.426	0.4299	0.4165	0.3996	0.4015	0.3736	0.3874
0.4373	0.3893	0.4147	0.3814	0.3889	0.369	0.367	0.3578
0.4593	0.3944	0.4373	0.3893	0.4147	0.3814	0.3898	0.3716
0.4813	0.4319	0.4562	0.426	0.4299	0.4156	0.4006	0.4044
QBLP676-IW-CW				QBLP676-IW-CW			
RC		RZ		RM		RR	
0.3736	0.3874	0.3551	0.376	0.3376	0.3616	0.3205	0.3481
0.3548	0.3736	0.3376	0.3616	0.3207	0.3462	0.3028	0.3304
0.3512	0.3465	0.3366	0.3369	0.3222	0.3243	0.3068	0.3113
0.367	0.3578	0.3515	0.3487	0.3366	0.3369	0.3221	0.3261
0.3736	0.3874	0.3551	0.376	0.3376	0.3616	0.3205	0.3481

Note:
Tolerance of measurement of color coordinates: ±0.01

Characteristic Curves

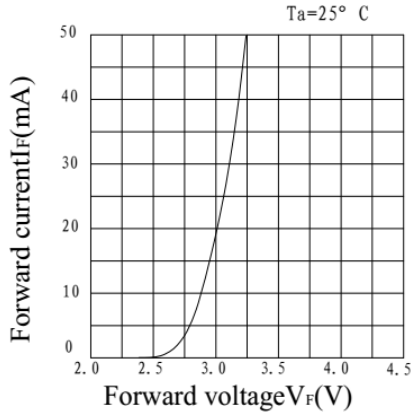

a) FORWARD CURRENT VS. FORWARD VOLTAGE

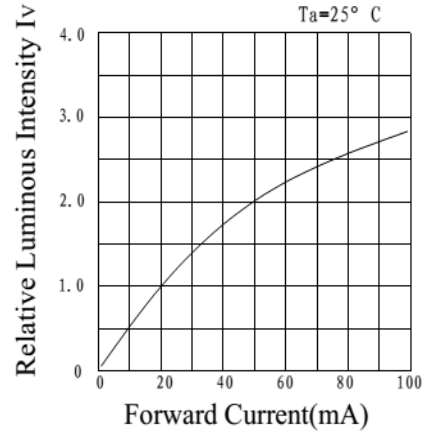

b) RELATIVE LUMINOUS INTENSITY VS. FORWARD CURRENT

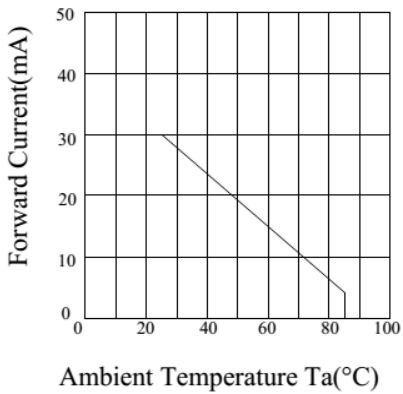

c) FORWARD CURRENT VS. AMBIENT TEMPERATURE

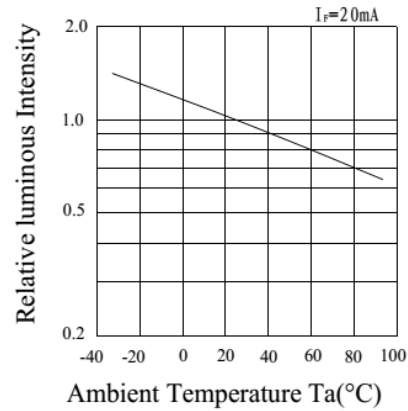

d) RELATIVE INTENSITY VS. AMBIENT TEMPERATURE

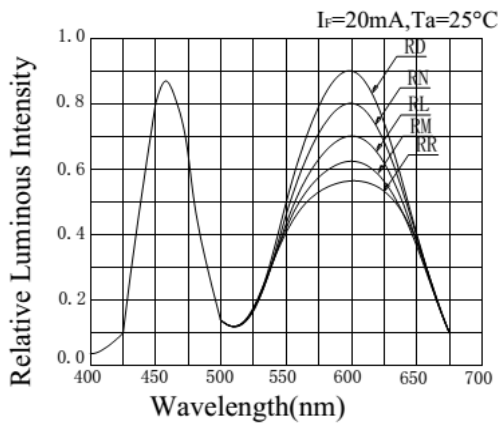

e) RELATIVE INTENSITY VS. WAVELENGTH

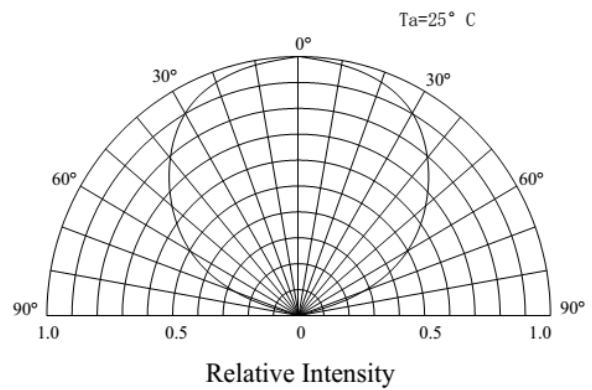

f) RADIATION PATTERN

Solder Profile & Footprint

- Recommended tin solder specifications: melting temperature in the range of 178~192 °C
- The recommended reflow soldering profile is as follows (temperatures indicated are as measured on the surface of the LED resin):

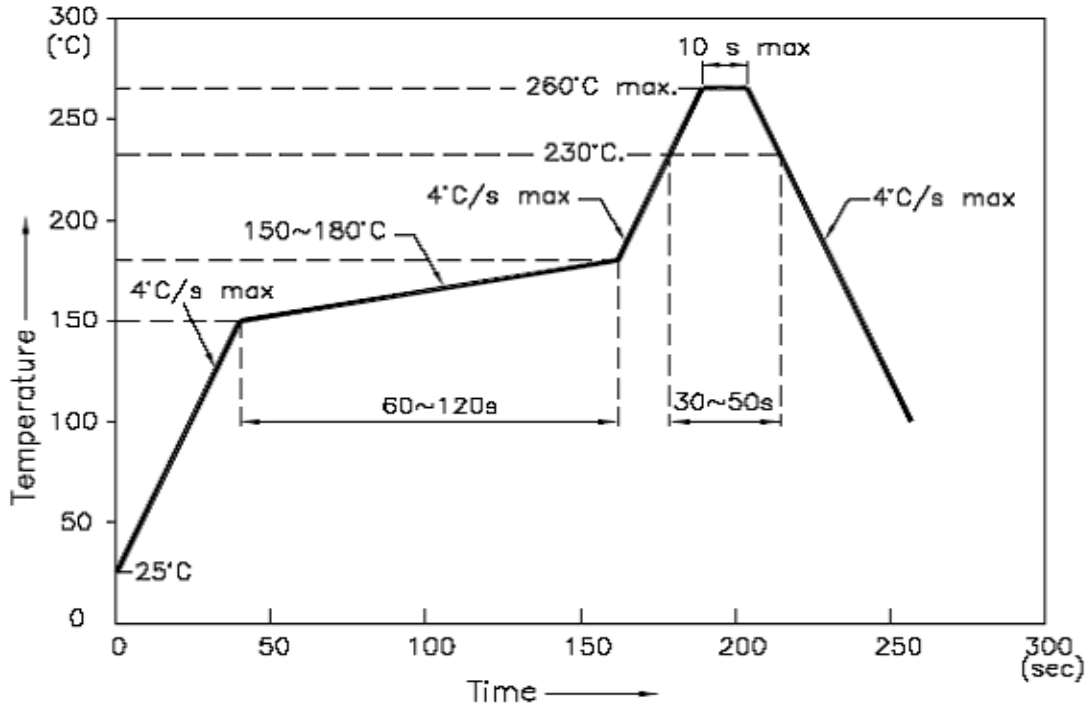

Recommended Pad Layout

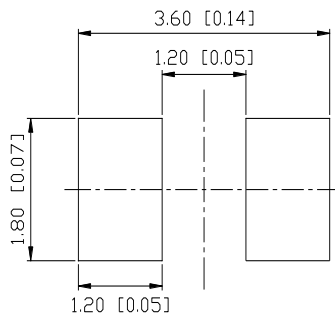

Units: mm

Tolerance: $\pm 0.2\text{mm}$

Packing

Reel Dimension:

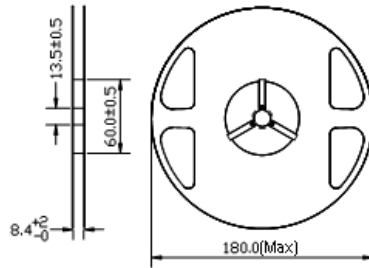

Unit: mm

Tape Dimension:

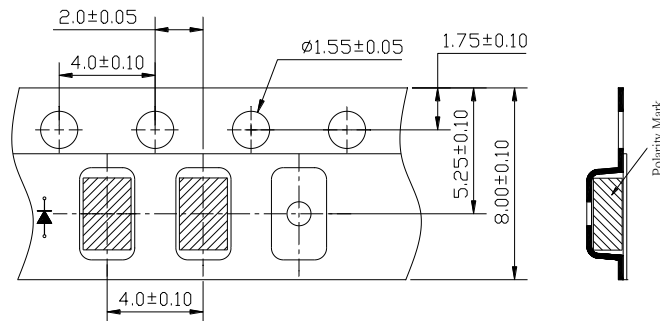

Unit: mm

Packaging Specifications:

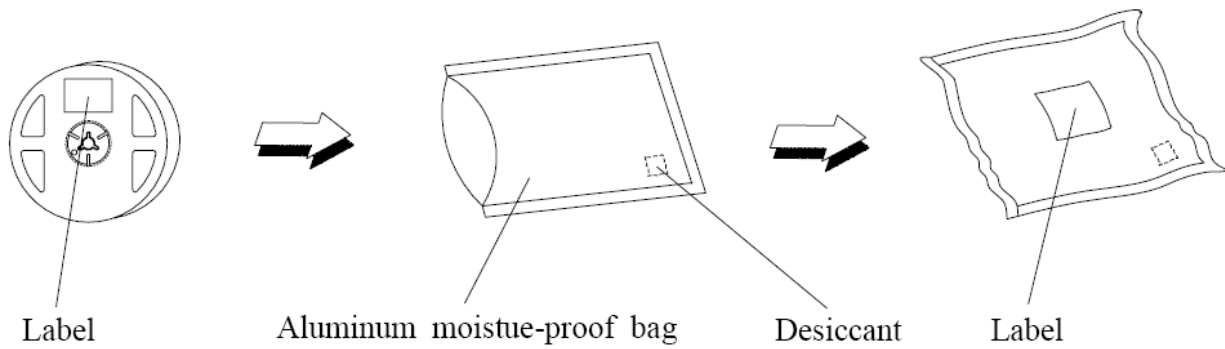

Labeling

Part No: _____

Customer P/N: _____

Item: _____

Q'ty: _____

Vf: _____

Iv: _____

WI: _____

Date: _____

Made in China**Ordering Information**

Part #	Orderable Part #	Spec Range	Quantity per reel
QBLP676-IW-WW	QBLP676-IW-WW	Iv=1950 mcd typ. @ 20mA / CCT=2760-3260K (RN) Bin	2,000 units
QBLP676-IW-NW	QBLP676-IW-NW	Iv =2000 mcd typ. @ 20mA / CCT=3640-4240K (RL) Bin	2,000 units
QBLP676-IW-CW	QBLP676-IW-CW	Iv=2000 mcd typ. @ 20mA / CCT=5300-7050K (RR & RM) Bin	2,000 units

Revision History

Description:	Revision #	Revision Date
New Release of QBLP676-IW	V1.0	06/24/2011
Add bin and CCT range	V1.1	11/22/2011
Updated part number	V1.2	2/6/2012
Update format, spec, and P/N	V1.3	04/12/2012
Update Spec	V2.0	02/12/2013
Update spec and drawing	V2.1	10/08/2013
Update drawing tolerance, add CRI info	V2.2	12/06/2013
Update drawing dimension and VF bin	V3.0	04/14/2017

Disclaimer

QT-BRIGHTTEK reserves the right to make changes without further notice to any products herein to improve reliability, function or design. QT-BRIGHTTEK does not assume any liability arising out of the application or use of any product or circuit described herein; neither does it convey any license under its patent rights, nor the rights of others.

Life Support Policy

QT-BRIGHTTEK's products are not authorized for use as critical components in life support devices or systems without the express written approval of QT-BRIGHTTEK. As used herein:

1. Life support devices or systems are devices or systems which, (a) are intended for surgical implant into the body, or (b) support or sustain life, and (c) whose failure to perform when properly used in accordance with instructions for use provided in the labeling, can be reasonably expected to result in a significant injury of the user.
2. A critical component in any component of a life support device or system whose failure to perform can be reasonably expected to cause the failure of the life support device or system, or to affect its safety or effectiveness.